

# **GASPARDO**



***IN-LINE DIRECT SEED DRILL  
RANGE***

# IN-LINE DIRECT SEED DRILL RANGE

## **GASPARDO EXPERIENCE AT YOUR SERVICE**

The GASPARDO in-line direct seed drills are the product of recognized experience and accumulated know-how to which whole generations of both engineers and farmers have contributed over almost two centuries in the business. Today, GASPARDO offers a comprehensive range of direct seed drills to cater to the demands of farmers and contractors, with an array of highly adaptable products with plenty of configuration options that place seeding quality, environmental sustainability and return on investment above all else.

The direct drilling range features models with mechanical or pneumatic distribution, and both fixed and folding frame versions.



## ***GASPARDO's background in DIRECT drilling***

In 1989, GASPARDO produces DIRETTA, the first in-line seeder for drilling seed into untilled soil.

Today, 30 years on from that first model, GASPARDO continues to perfect its creations, introducing innovations that have allowed our direct drilling machines to set a benchmark for farmers and contractors

**GIGANTE PRESSURE**





GASPARDO seeding unit	4
The perfect seeding line	6
Features	8
GENIUS MASTER	10
Pneumatic distribution	12
GIGANTE PRESSURE	14
Pressurized distribution	16
Mechanical distribution	18
DIRETTA	20
DIRETTISSIMA	22



## AGRONOMIC BENEFITS

- *Increased soil fertility*
- *Increased organic matter and humus*
- *Increased crop-benefiting microbial activity*
- *Less soil compaction*
- *Less oxidative stress on soil*
- *Less risk of water ponding*
- *Less soil erosion*



## FINANCIAL BENEFITS

- *Less time spent working soil*
- *Great fuel savings for field operations*
- *Increased work window*
- *Minimized machine inventory*
- *Less financial risks in the case of extraordinary weather events*



## ENVIRONMENTAL BENEFITS

- *Ultimate epitome of Conservation Agriculture*
- *Soil serves as CO<sub>2</sub> sink*
- *Reduced emission of climate-changing gases*
- *Minimal loss of fertile soil to erosion*
- *No destruction of soil's structural colloidal system*

# ***GASPARDO seeding unit***

## ***GASPARDO, your direct line to quality!***

The seeding unit designed and manufactured entirely by GASPARDO delivers reliable, quality direct drilling, regardless of seed type and actual conditions in the field, even where there is a lot of stubble to contend with. The considerable down pressure (up to 260 kg) allows it to easily cut a seeding line even through tough soil. Seeding depth remains constant thanks to the independent furrow-opening and furrow-closing movements. GASPARDO direct seed drills offer an extensive range of adjustments, to better adapt to soil conditions and the farmer's own preferences.



## **KEY POINTS**

***Unit height spring: adjusts soil cutting depth***

***Soil scraper with WIDIA plate***

***Interchangeable depth gauge wheel***

***Disc coulters Ø 475 mm***

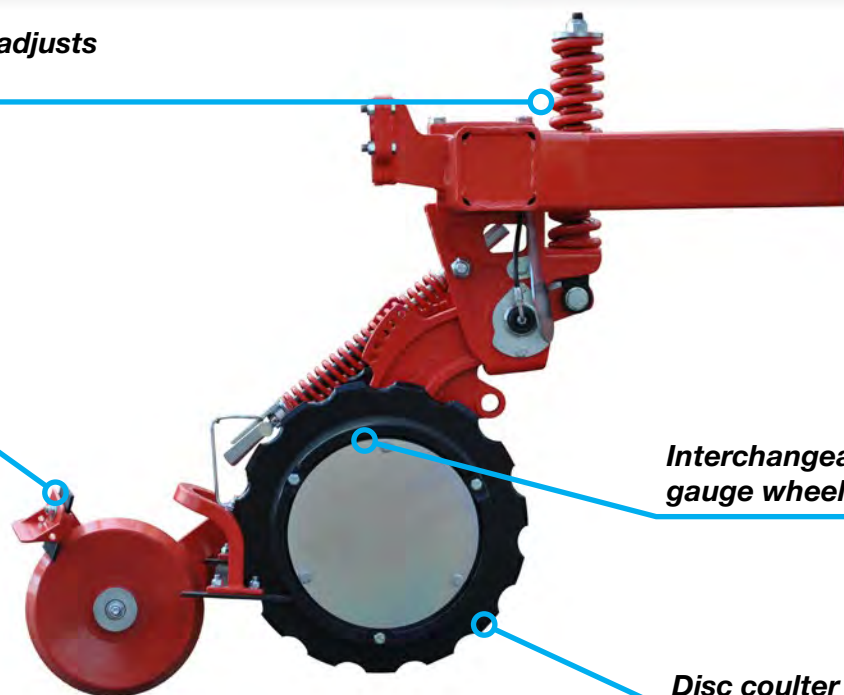

# Always at the cutting edge

## **CROP RESIDUE CUTTING**

The shoe cuts any crop residue so that it does not get in the way of seed growth.

## **SEED FURROW CREATION AND SEED DROP**

The special shape of the coulter is responsible for creating the seed furrow and the seed is dropped in.

## **FURROW CLOSING**

The seed press wheel has a truncated cone shape designed for excellent furrow closing, producing the right conditions to promote germination.

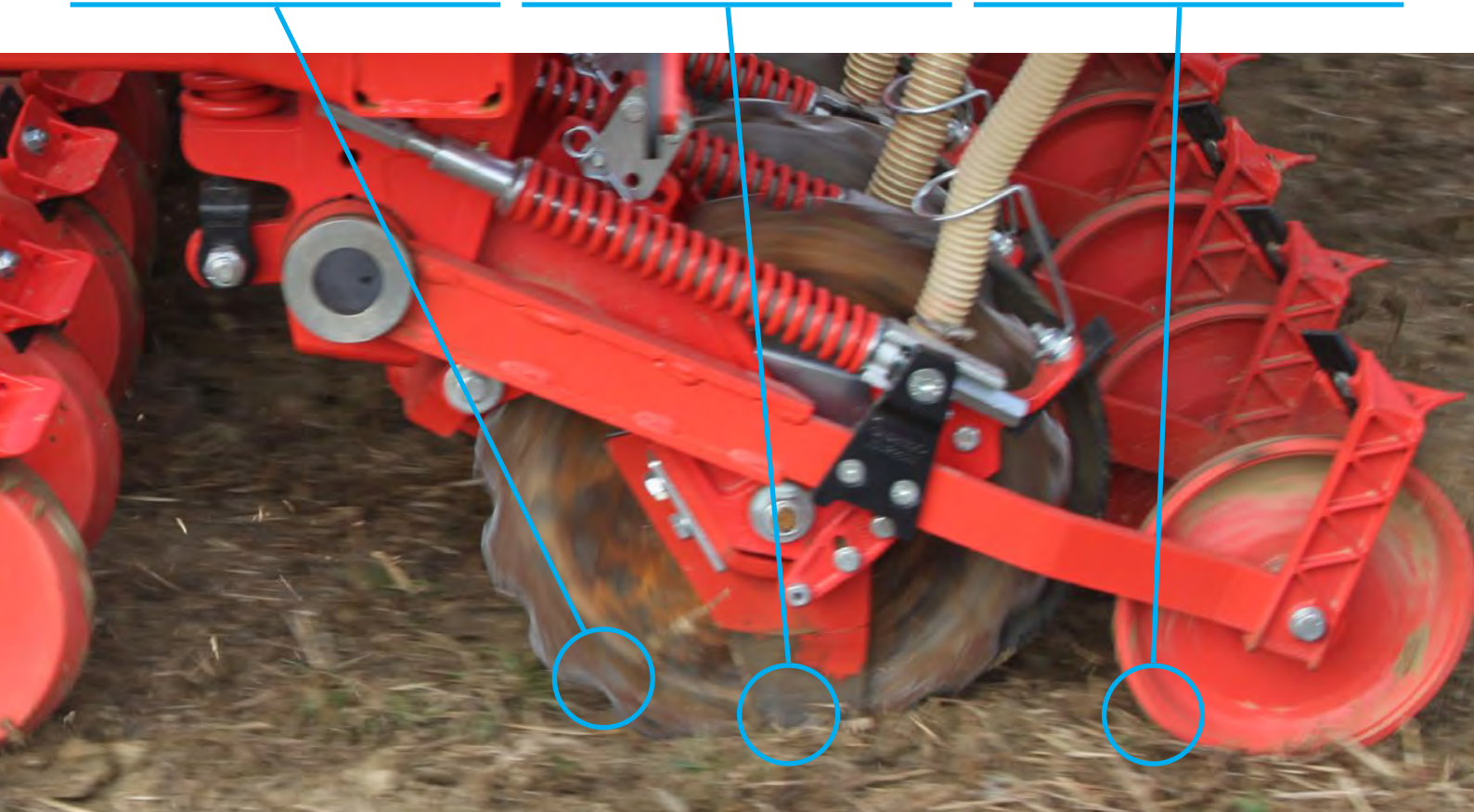

**Closing wheel pressure adjustment spring**

**Closing wheel**

**Seed press wheel arm operated independently**

**Interchangeable wear-resistant cast iron shoe**

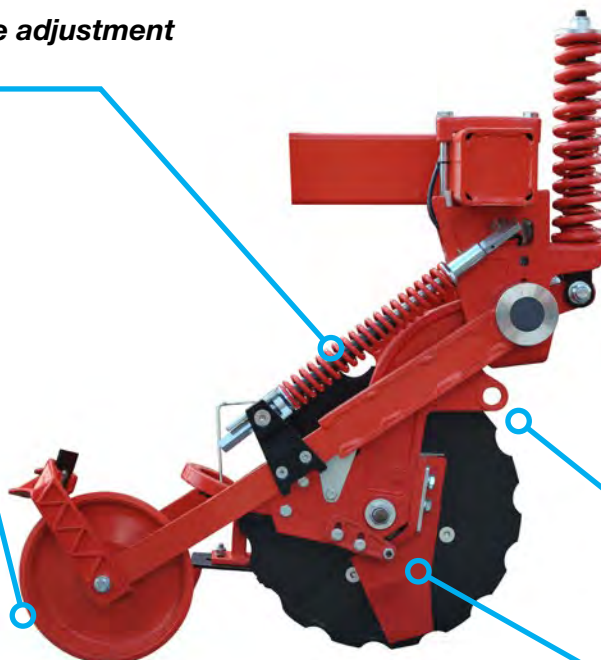

# The perfect seeding line

## THE RIGHT COULTER FOR EACH SITUATION

The 6mm-thick coulters with a diameter of 475 mm easily slice through soil and aggressively cut back crop residue.

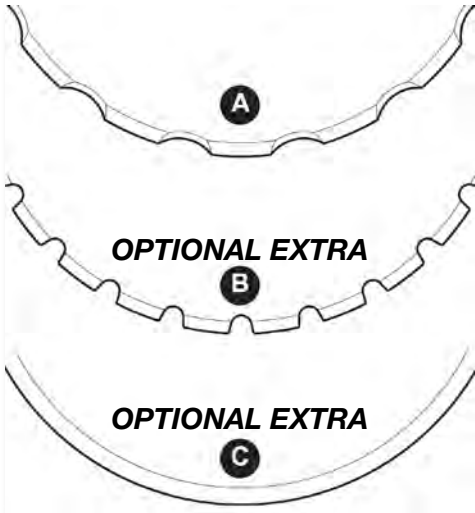

There are 3 different cutting profile options:

**A) Shallow notched disc:** impressive cutting capacity, suitable for common direct drilling techniques, even on very wet ground.

**B) Deep notched disc:** effective bite in soft and sandy soils.

**C) Plain disc:** unbeatable residue cutting capacity, suitable both for very tough, dry soils, and for situations where forage is cut flush with the ground, where the surface is to remain clear.

## ANGLES THAT COUNT

The disc's double 2° angle has been designed to optimize the seed's germinative conditions in untilled soil, including wet and tough soil, in addition to ensuring less power draw for pulling.

$\alpha = 2^\circ$  converging on horizontal axis

$\beta = 2^\circ$  angle to vertical axis

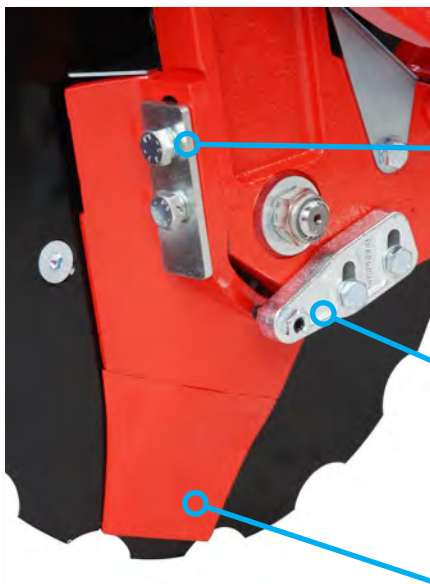
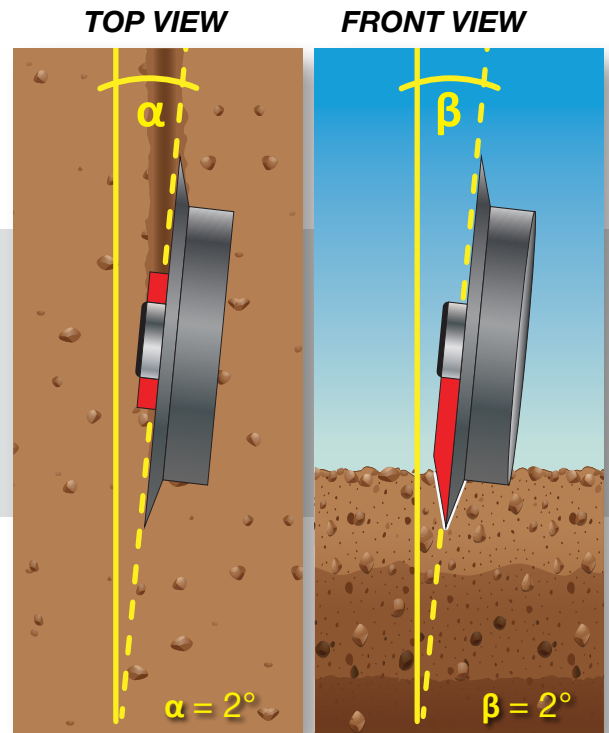

**Shoe height adjustment screws**

**Cast steel shoe retainer**

**Interchangeable point**

## FAST ROOT GROWTH

The GASPARDO seeding unit shoe is the part that forms the seedbed and drops in the seed. It forms the ideal germination environment, generating a fine-textured soil for subsequent closing of the seed furrow, without compacting its walls. Its tapered profile reduces resistance to forward travel, and ensures materials have a longer service life. The shoe is height adjustable, while the point is interchangeable so it can be replaced.

# The right depth for each seed

## ACCURATE SEEDING DEPTH CONTROL

The various tapered gauge wheels ensure the unit sits stably on the ground, and thanks to the considerable down pressure, deliver consistent seeding depth, even when encountering obstacles during forward travel. There are two solutions to choose from, depending on the type of soil, crop and operating condition in the field:

- **Cast steel series:** comprises 3 types of gauge wheels fastened to the disc coulters that can be swapped out quickly based on the farmer's needs.
- **Farmflex wheel:** soft rubber gauge wheel with quick seeding depth pin adjustment.



### **Standard Cast steel**

Diameter: 360 mm  
Width: 70 mm  
Depth: 5 cm  
For deep seeding on normal, tough or wet ground.



### **Optional extra Cast steel**

Diameter: 400 mm  
Width: 70 mm  
Depth: 3 cm  
For surface seeding on normal, tough or wet ground.



### **Optional extra Cast steel**

Diameter: 400 mm  
Width: 110 mm  
Depth: 3 cm  
For surface seeding on very wet ground.



### **Optional extra Rubber Farmflex**

Diameter: 400 mm  
Width: 115 mm  
Depth: 0-8 cm  
For light, dry or minimum tilled loose soils.

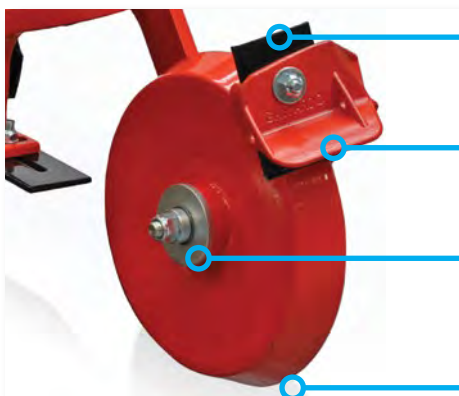

**Soil scraper with Widia plate**

**Deflector for wet soil**

**Bearings with two rows of balls  
for greater hold**

**Tapered cross-section for  
directing soil into the furrow**

## EFFECTIVE SEED FURROW CLOSING

With its truncated cone shape and slight angle to the vertical, the closing wheel is designed to cover the seed with the soil displaced by the shoe. The rocker arm, which is independent from the furrow opener, is designed to allow the unit to follow the undulating contours of the ground, even on very uneven ground. Down pressure can be adjusted with a spring.

## NO CLOGGING WITH RESIDUE

Available as an optional extra, the anti-clogging steel guard stops crop residue from hindering the closing wheel's rotation.

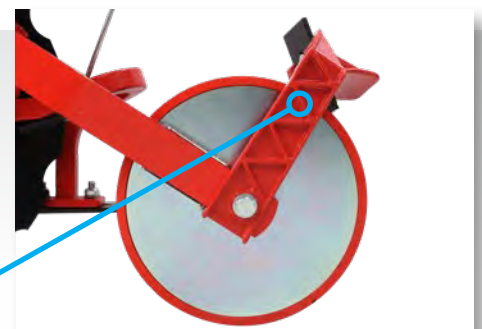

**Cast steel soil scraper mount**

# Features

## ...worthy of a top-class machine



**A**



**B**

### **EXCEPTIONAL IN-FIELD MANOEUVRABILITY AND STABILITY**

GASPARDO direct seed drills have an articulated drawbar connected to the tractor's lift **(A)**. This system allows for easy manoeuvring, even in the tightest spaces, thanks to the 2-way swivel joint. In addition, it means the front of the seed drill can be lifted.

The DIRETTISSIMA model comes with the option of a tow eye attachment **(B)**, which is particularly suitable for coupling to crawler tractors.

### **18CM ROW SPACING**

GASPARDO direct seed drills have a standard 18cm row spacing. With the units laid out in two opposite rows, weight is perfectly balanced and the implement does not drift off to the side as it is pulled.

Row spacing can be doubled to 36 cm by disengaging every other row, and this goes for both mechanical and pneumatic distribution models.

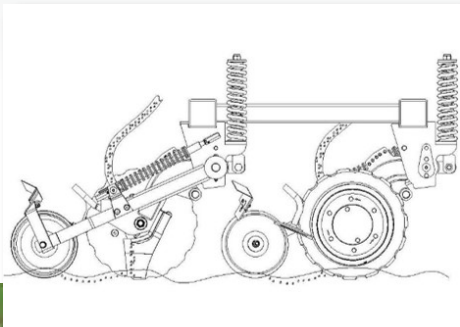
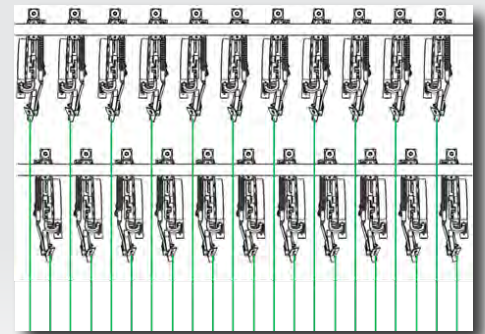

### **HIGH GROUND CLEARANCE**

The coulter units are arranged in 2 well spaced out rows to stop the components clogging, especially on ground with a lot of residue. This feature is further complemented by the units' high ground clearance.





# Here's the drill!



## **POST-SEEDING FINISHING**

The seed-covering harrow performs finishing, evening out the seeded surface. If you are dealing with crop residue, the harrow can be disengaged to avoid clogging. Bar tilt and down pressure are quick and easy to adjust.

## **LIFTABLE ROAD WHEELS**

Wheels for road travel can be lifted out of the way hydraulically while working for improved down pressure and to avoid wheels running over the seed that has just been placed. This can be a useful feature when working in very wet conditions, making the seed drill easier to pull.



## **NARROW ROW SPACING**

The range includes models for 15cm reduced row spacing (DIRETTA and GIGANTE PRESSURE). This is an especially attractive solution when dealing with grassland groundcover and whenever stubble is very long.



# GENIUS MASTER

AEF Certified



## ISOBUS UNIVERSAL LANGUAGE

GENIUS MASTER makes communicating with electrically driven seed drills highly intuitive through the tractor's ISOBUS terminal: a single connecting cable is used to link the seed drill/tractor for monitoring and controlling all seeding functions.



A single connecting cable



Versatility for application with our other equipment



Universal language with the main tractor brands

## SOLUTIONS FOR NON-ISOBUS TRACTORS

GASPARDO supplies a compatibility kit, which comprises the ISOBUS terminal and cabling to enable communication between electrically driven seed drills and non-ISOBUS tractors.

### Tera 7 - Universal Monitor

ISOBUS monitoring functions - read only:



Backlit 7" graphic display

- Seeding density control
- Manual seeding shut-off
- Seeding alarms
- Seeding parameter display

### Touch 800 - ISOBUS Terminal

Advanced ISOBUS monitoring functions (read+precision farming):



Backlit 8" graphic display

- TERA 7 functions
- Prescription map import
- Georeferenced seeding data export
- Automatic seeding shut-off
- Variable input rate



# ISOBUS and Precision Farming

## ELECTRICALLY DRIVEN SEED DRILLS

The revolutionary GASPARDO electric-drive system based on the ISOBUS communication protocol is an innovative solution that simplifies the seed drills' mechanical construction: in lieu of gearboxes, chains and belts, the tractor's terminal becomes the control centre during seeding. As a result, adjustment is quick and easy, with setup taking considerably less time.



















## TECHNOLOGY CATERING TO FARMERS' NEEDS

- Less mechanical parts to maintain
- Seeding density managed directly via the tractor terminal
- Seeding functions monitored and changed in real time
- ISOBUS communication between seed drill and tractor
- Management via GENIUS MASTER
- Precision Farming: variable rate and automatic section shut-off
- Remote link with MG-Live (Agriculture 4.0)

## TECHNOLOGY AT THE CUTTING EDGE OF PRECISION FARMING

The GENIUS MASTER system manages all Precision Farming-related ISOBUS functionalities. In this sense, the terminal takes information from the prescription maps on the conformation and variable fertility of soils, relaying relevant automatic commands to the ISOBUS electrically driven seed drill.

		Tera 7	Touch 800		
	ISOBUS universal terminal			Sections are switched on and off automatically. There is no overlapping of seeding areas.	
	Data transfer to PC			You can read prescription maps and export field operation data.	
	Variable rate			Variable seeding density depending on the land's different production zones.	
	Automatic section control			Sections are switched on and off automatically. No overlapping of areas that have already been sown.	

# Pneumatic distribution

## THE RIGHT ROLLER FOR EVERY NEED

Based on the type and shape of the seed to be distributed, there are four metering rollers to choose from for the seed, and one for the fertilizer. They have different configurations to deliver the right seed rate, and hence speed of rotation, depending on the seed, the target population and the width of the machine. A high number of staggered flutes ensures even distribution, and delivery is never "pulsed". There are rollers available with blind flutes to reduce the metering rate while maintaining a suitable speed of rotation. The aluminium casing of the meter and the plastic used for the rollers ensure long service life and corrosion resistance.

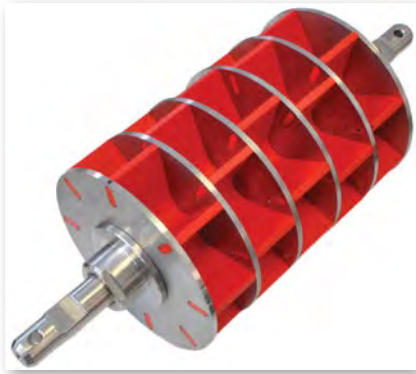

### G1000 – HIGH SEEDING DENSITY

For distributing medium and large seed at high rates (over 250 kg/ha).

### F25-125 – SMALL SEEDS

Ideal for fine seeds, which are generally distributed at low rates. Option of dropping the amount distributed to less than 3 kg/ha by disengaging one or more segments of the roller.



### N500 – MEDIUM SEEDING DENSITY

Suitable for seeding autumn-winter cereals at medium rates (up to 250 kg/ha).



### G626 – FERTILIZER

Suitable for localized fertilizer distribution at the same time as seeding.



### G1000 R26 – LARGE SEEDS

Suitable for large seeds. The concave shape proves useful for avoiding breakage as a result of the seed's size.

# Simple, intuitive adjustment

## **CONVEYED VOLUMETRIC SEED AND FERTILIZER METERING**

Volumetric metering units combined with the GASPARDO pneumatic seed and fertilizer conveying system deliver accurate, even sowing every time. The seed and fertilizer hoppers have been carefully designed to ensure sufficient capacity for extended operating time between fills and simultaneous reloading. The two products are metered independently, conveyed along the seed tube and delivered into the same furrow by the pneumatic system.



## **SEEDING WITHOUT DELAY OR WASTE**

The automatic PRE-START function preloads the metering rollers with product to avoid seeding delays at restart.

The manual PRE-STOP function instead stops distribution early, to avoid overlapping or loss of product at the end of the field.

## **DOUBLING ROW SPACING**

By changing the cover on the distribution head, you can disengage the second seed row to double the row spacing from 18 to 36 cm.

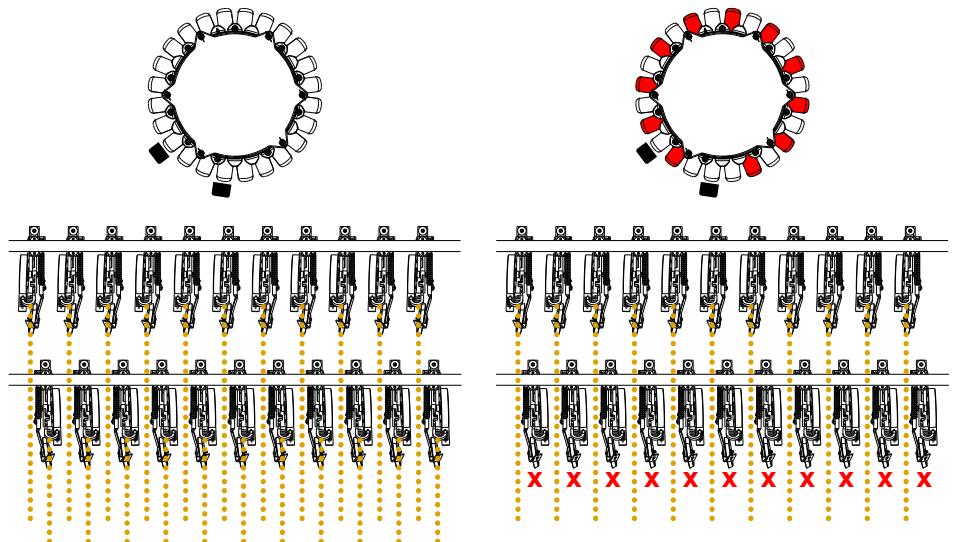
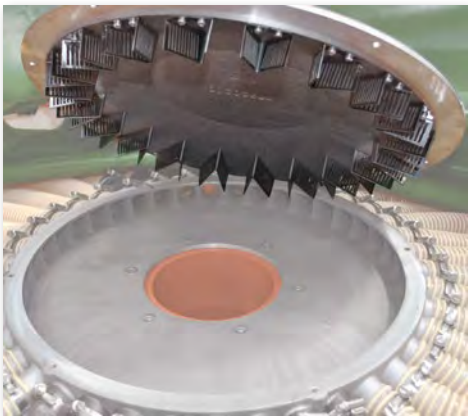

# GIGANTE PRESSURE

*Pneumatic seed drill with pressurized hopper*



## **GIGANTE PRESSURE**

GASPARDO's flagship model in the direct drilling range with pneumatic seed and fertilizer distribution, available in both fixed and folding frame versions. The innovative pressurization system optimizes distribution efficiency from the hopper to the seed furrow. With the hopper's lowered centre of gravity, GIGANTE PRESSURE's manoeuvrability is second to none, even when faced with steep slopes.

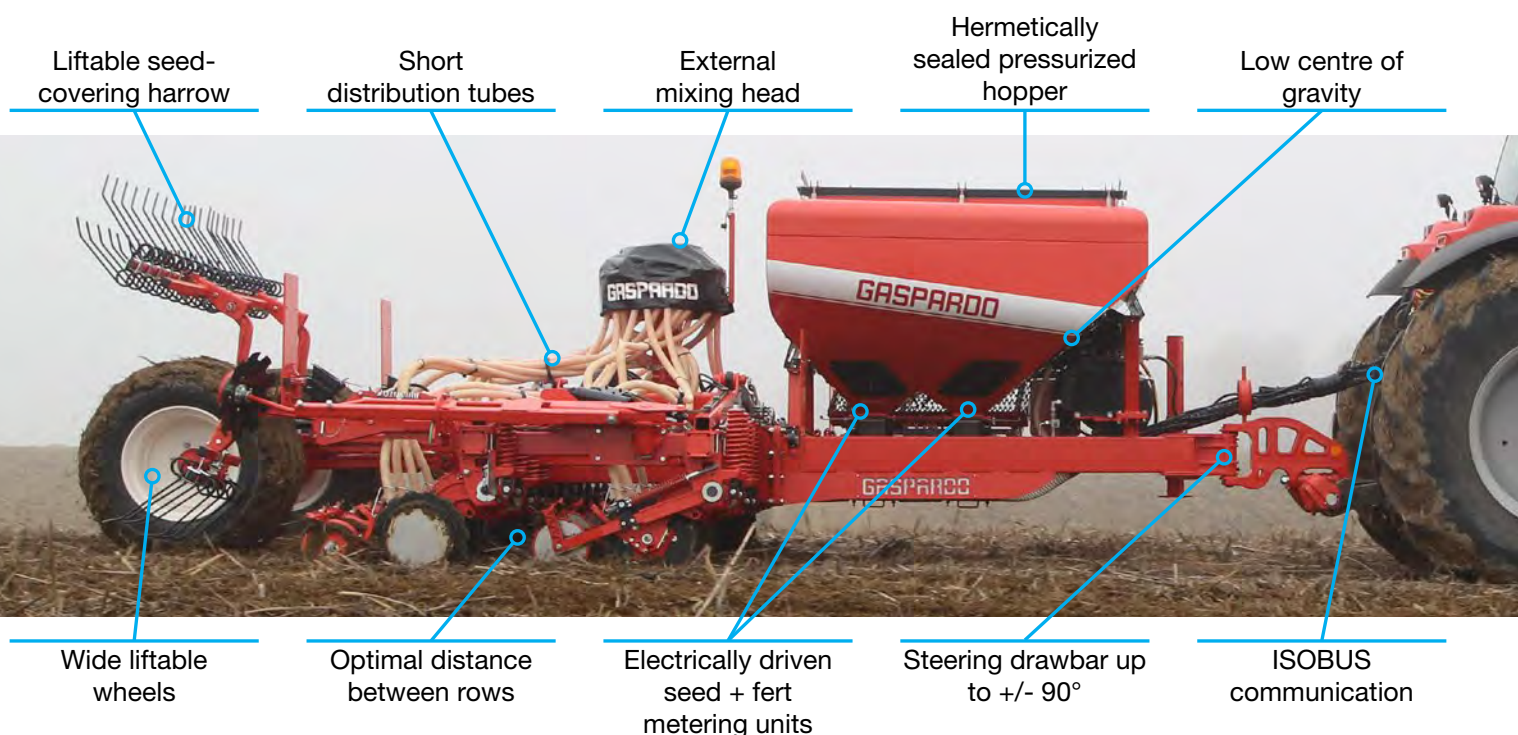



## GIGANTE PRESSURE



### ISOBUS digital seeding

The metering units' electric-drive system makes GIGANTE PRESSURE a fully digital control solution. The tractor's ISOBUS terminal handles seed calibration and work parameter control. In addition, it allows you to access the Precision Farming functions, such as variable rate and automatic section shut-off.

### Centralized greasing

A feature unique to GIGANTE PRESSURE is the centralized greasing point, conveniently located on the side of the machine, to which the rotating pins of each unit are connected. This optional kit lets you reduce the additional time taken to perform routine maintenance on the seeding units.



MODEL	VERS.	ROWS (no.)	ROW SPACING (cm)	ON-ROAD WIDTH (cm)	SEED / FERTILIZER HOPPER (L)	WHEEL WEIGHT CAST IRON / RUBBER (kg)	MIN. TRACTOR POWER (HP/kW)
GIGANTE PRESSURE	300	17	15 - 18	310	1860/980	4226/4090	184/135
	400	22			1860/980	5520/5360	184/135
	500	28			2240/1170	7090/6850	200/150
	600	33			2240/1170	7340/7100	200/150

# Pressurized distribution

## QUALITY DISTRIBUTION AT PEAK EFFICIENCY

The GASPARDO pressurized distribution system ensures even more accurate and even product delivery than regular systems, reducing the blower's energy consumption.

The pressure created is the result of the air generated by the blower introduced into the hopper, which is hermetically sealed by the top hatch.

Pressure is kept constant as product empties from the hopper, translating into excellent distribution quality regardless of working condition, especially on steep slopes.

- A** PRODUCT CONVEYING BLOWER
- B** AIRFLOW FOR PRESSURIZATION
- C** HERMETICALLY SEALED HATCH
- D** ELECTRICALLY DRIVEN SEED METERING UNIT
- E** ELECTRICALLY DRIVEN FERTILIZER METERING UNIT
- F** CONVEYING LINE WITH NO CHOKE POINTS
- G** EXTERNAL DISTRIBUTION HEAD

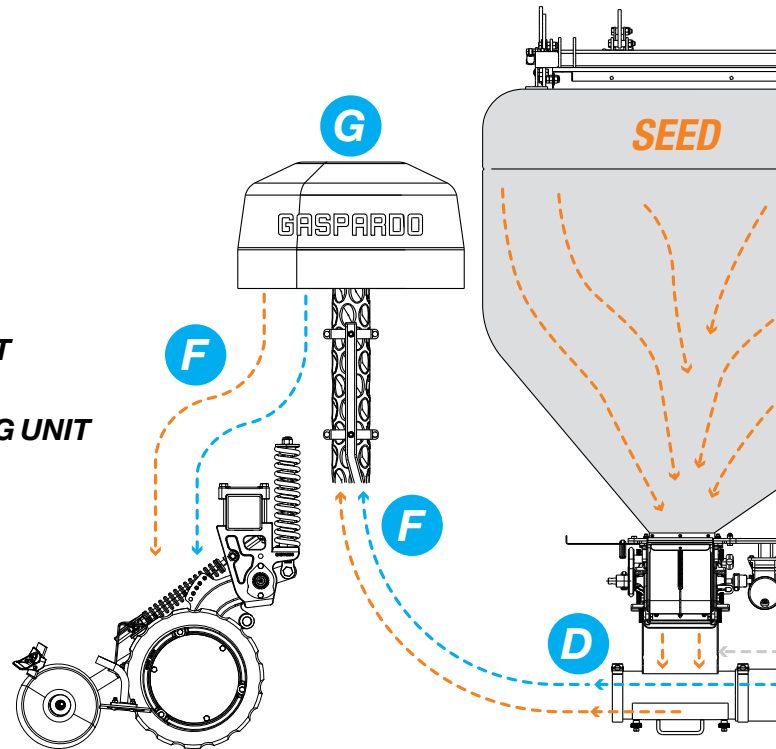

## DIGITAL SEED CALIBRATION

With the GENIUS MASTER digital system, calibration on the GIGANTE PRESSURE is quick and simple. The calibration box on the seed drill or ISOBUS terminal operative the electrically driven metering units directly to perform product weighing on the precision scale (provided).

## ACCESSORIES



**PTO coupling**  
sizes Z8-Z20-Z21 to Z6



**Pump gearbox**  
540 rpm 3/8" Z6

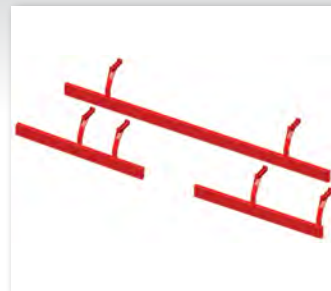

**Stalk-stomper front bar**



**Electronic scale for metering calibration**



# High crop efficiency

## LOWERED CENTRE OF GRAVITY

With the pressurization of the hopper and externally located distribution head, GIGANTE PRESSURE has a very low centre of gravity. This feature becomes vitally important above all when sowing in very steep areas, making for excellent machine manoeuvrability as well as stability.

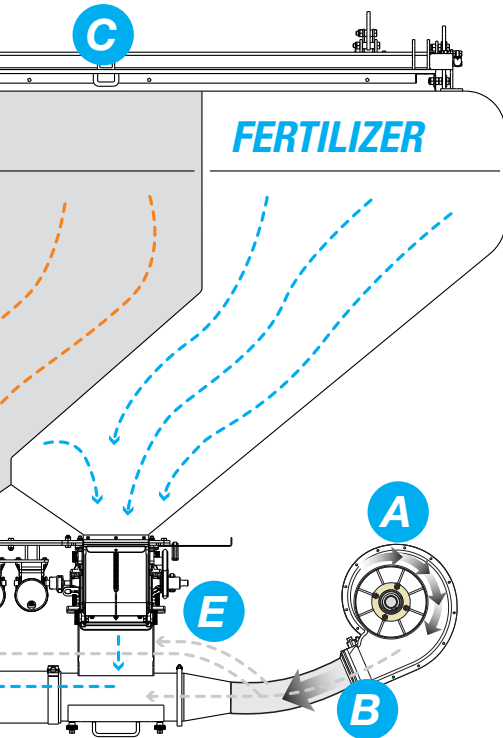

## WELL-DESIGNED HOPPER

The GIGANTE PRESSURE pressurized hopper is split into two compartments: 2/3 for seed and 1/3 for fertilizer. The funnel shape ensures product is fed into the metering units even on steep ground, on both side and longitudinal slopes. The radiused interior makes for easier cleaning. Because the distribution head is located on the outside, it maximizes the hopper's interior capacity to hold more product.



## SEED AND FERTILIZER IN A SINGLE PASS

The GIGANTE PRESSURE distribution system allows you to spread seed and fertilizer in a single pass of the field, promoting great root efficiency in assimilating the product. Ideal for optimizing the rapid germination effect with phosphorus-based fertilizers, especially in untilled soil, given the immobility of this nutrient.



**Manual row shut-off**



**Single electric row shut-off  
(max. 9+9 motors)**



**Pneumatically controlled braking system**



**Hydraulically controlled braking system**

# Mechanical distribution

## **ALL-ROUND QUALITY SEEDING**

The GASPARDO mechanical distribution system ensures correct, even product metering along the full sowing width.

The GASPARDO series of metering rollers makes it possible to work with a wide range of seed types: from fine seeds like rapeseed, clover and grass, to larger diameters like cereals, soya, peas and tic beans, without compromising seeding uniformity. The GASPARDO mechanical distribution models, like DIRETTISSIMA and DIRETTA, can distribute product at rates ranging from 2 to 500 kg/ha.

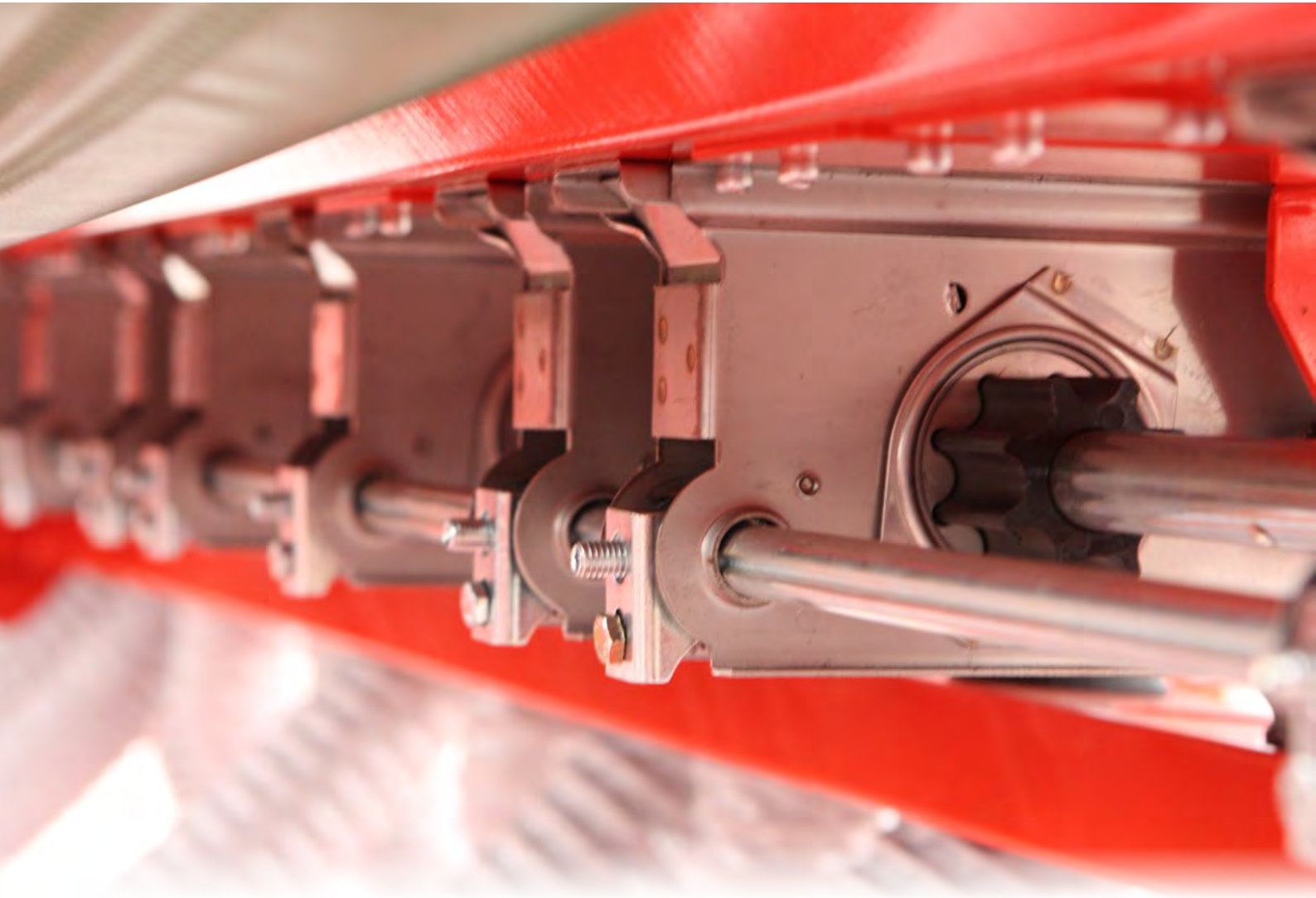

## **DRIVE WHEEL**

On the DIRETTISSIMA and DIRETTA models, motion is transmitted to the seeding units by a toothed groundwheel that bites into the soil while the machine is working. This sets a kinematic chain in motion, driving the gearbox and metering units.

# 4 steps for the perfect adjustment!

## **SIMPLE, FAST ADJUSTMENT**

The GASPARDO mechanical distribution system allows for accurate metering of different types of seeds. With the quick and versatile adjustment system, you can tailor the seed drill's setup to suit individual requirements. The manual that comes with the machine and the tables on the seed drill itself are provided to help you with the adjustment procedure. This makes it really quick and simple to adjust the system from one type of seed to the next, following the 4 steps below.

# 1

### **POST-SEEDING FINISHING**

The seed-covering harrow performs finishing, evening out the seeded surface. If you are dealing with crop residue, the harrow can be disengaged to avoid clogging. Bar tilt and down pressure are quick and easy to adjust.



# 2

### **PROBE ADJUSTMENT**

The correct positioning of the probes ensures gentle treatment of the seed in order to avoid breakage and to maintain smooth, constant distribution.

The probe adjustment lever is situated on the left side of the machine and can be set from 0 to 9 along a graduated scale depending on seed size.



# 3

### **SETTING SHUTTER SLIDES**

The outlet shutter slides have three positions for adjusting the quantity of seed exiting the hopper.



# 4

### **METERING ROLLERS**

Depending on the size of the seed, you can choose the most suitable combination of rollers for the job. The small peg roller is recommended for small seeds; while a key can be inserted in the hole to engage the large peg roller, which becomes integral with its smaller counterpart to distribute more seed or to handle larger seeds.



# DIRETTA

Fixed-frame mechanical seed drill



## DIRETTA

Ideal solution for mid-sized farmers who are committed to the direct drilling technique and who work on flat or gently sloping land. DIRETTA features a fixed frame 3 or 4 metres wide with mechanical distribution. It is semi-mounted - connected to the tractor via a two-point hitch and articulated towbar - giving it excellent manoeuvrability both on road and for turning at the ends of the field. The generous hopper means seed reloading intervals are increased, for longer operating time between fills.



## LOADING PLATFORM

The loading platform located on the back of DIRETTA is designed for easy and safe loading of product into the hopper from big bags. In addition, it makes it easy to inspect the machine, where necessary, once the job is done.

## KEEP A CHECK ON ALL PARAMETERS WITH THE BEST TERMINAL FOR THE JOB

A specialist in the seeding field, GASPARDO offers an array of terminals that can be used on mechanical-drive models, complete with displays for controlling both working parameters and special sowing functions.



### HCS

- Area worked, partial and total



### MULTICONTROL

- Area worked, partial and total
- Forward speed
- Metering unit speed control
- Hopper seed level alarm
- Blower speed control
- Tramlining



## DIRETTA

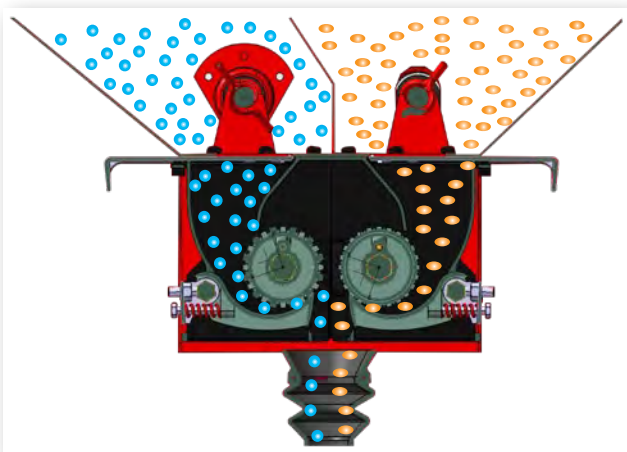

### **DIRETTA CORSA:**

#### ***combined seed and fertilizer distribution***

The DIRETTA CORSA version is designed to sow seed and distribute fertilizer at the same time by virtue of a hopper split into two compartments. The fertilizer is placed in contact with the seed inside the seed furrow, thus optimizing the product's efficiency.

In addition, DIRETTA CORSA has two independently adjusted gearboxes: one on the right for distributing seed and one on the left for distributing fertilizer.

MODEL	VERS.	ROWS (no.)	ROW SPACING (cm)	ON-ROAD WIDTH (cm)	SEED / FERTILIZER HOPPER (L)	WHEEL WEIGHT CAST IRON / RUBBER (kg)	MIN. TRACTOR POWER (HP/kW)
DIRETTA	300	17	18	314	2090	3900/3760	110/81
		19	15.6	314	2090	4090/3945	
	400	22	18	410	2880	4450/4280	150/110
DIRETTA CORSA	300	17	18	314	1260/830	3900/3760	110/81
		19	15.6	314	1260/830	4090/3945	
	400	22	18	410	1740/1140	4450/4280	150/110

# **DIRETTISSIMA**

**Fixed-frame mechanical seed drill**



## **DIRETTISSIMA**

The smallest and lightest in the GASPARDO direct drilling range, a 2.5m-wide model whose weight makes it ideal for direct drilling in steep ground, light-textured soil or following minimum tillage, pulled by medium-/low-powered tractors (80-100 hp). Despite its light weight, DIRETTISSIMA delivers a unit down pressure of 150 kg.

## **HOPPER LEVEL**

The seed level in the hopper is easy for the operator to check without leaving the driver's seat by means of a mechanical indicator.





**DIRETTISSIMA**



**TOW EYE DRAWBAR**

DIRETTISSIMA can be ordered with the seed drill tow eye drawbar kit as an optional extra. This is an attractive solution for hooking up to low-powered crawler tractors, ideal for working in very hilly areas.

**HCS MONITOR**

DIRETTISSIMA features a monitor that gives partial and total worked area counts, providing the user with the most comprehensive, accurate readings.



MODEL	ROWS (no.)	ROW SPACING (cm)	ON-ROAD WIDTH (cm)	SEED HOPPER (L)	WEIGHT (kg)	MINIMUM TRACTOR POWER (HP/kW)
DIRETTISSIMA	13	17.8	250	560	1800	100/73

# GASPARDO

**MASCHIO GASPARDO S.p.A.**

Headquarters and production plant  
Via Marcello, 73  
I-35011 Campodarsego (PADUA) - Italy  
Tel. +39 049 9289810 - Fax +39 049 9289900  
info@maschio.com - www.maschio.com

**Production plant**

Via Mussons, 7  
I-33075 Morsano al Tagliamento (PN) - Italy  
Tel. +39 0434 695410 - Fax +39 0434 695425